

HIGH-TEMPERATURE DILATOMETER WITH PYROMETER MEASURING SYSTEM AND RATE-CONTROLLED SINTERING CAPABILITY

S. Winkler · P. Davies** and J. Janoschek**

* NETZSCH-GERÄTEBAU GMBH, P.O. BOX 1460, D-8672 SELB, FRG

** NETZSCH MASTERMIX LTD., VIGO PLACE, ALDRIDGE, WALSALL, WEST MIDLANDS,
WS9 8UG, UK

An optical pyrometer is used to measure and, in conjunction with temperature programmer and controller, control the temperature of the NETZSCH Dilatometer DIL 402 E/7 up to 2400°C. This instrument is thus suitable to investigate sintering of technical ceramic materials such as SSiC and ZrO₂. Measurements carried out on these materials containing organic additives show that the sintering range of SSiC starts at 1800°C – although its final density is not reached at 2400°C at a heating rate of 20 deg·min⁻¹ – and that the densification of ZrO₂ occurs between 1000° and 1800°C. Using rate controlled sintering (RCS) the sintering process can be extended on a time scale, but the same densities are obtained at the same temperatures when comparing the measurements with and without RCS.

Keywords: high-temperature dilatometer, optical pyrometer, SSiC, ZrO₂-Y₂O₃

Introduction

Development of structural high-performance ceramics such as pressureless sintered SiC (SSiC) or ZrO₂ with respect to their possible applications in heat engines made it necessary to extend the temperature range of the NETZSCH dilatometer DIL 402 E/7 to 2400°C [1]. Investigation of the densification process that occurs at about 2000°C for SSiC is of great importance for production of parts with high mechanical strength. Thus dilatometry is invaluable for determining start and end temperatures of the densification process, expressed both as change in length of the sample and as calculated change in density. This is performed automatically via software [2, 3]. This paper first describes the NETZSCH DIL 402 E/7 dilatometer with optical pyrometer, and then its use in investigating the sintering of ZrO₂ and SSiC.

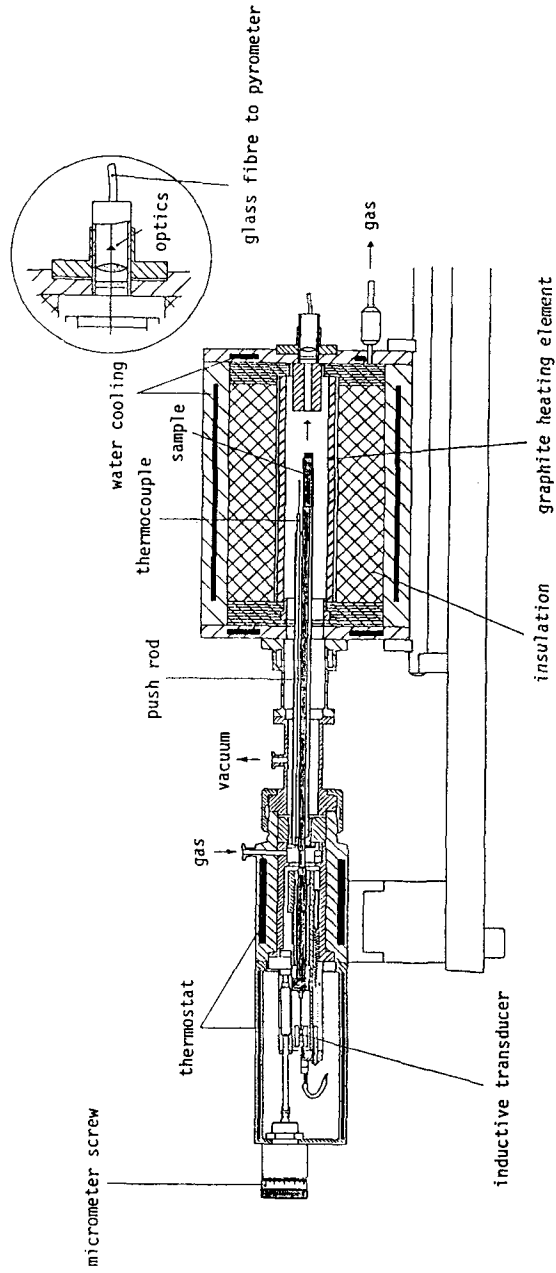

Fig. 1 Schematic drawing of the high-temperature dilatometer NETZSCH DIL 402 E/7 with optical pyrometer for temperature measurement

Experimental

NETZSCH DIL 402 E/7 dilatometer

Figure 1 is a schematic of the instrument.

The DIL 402 E/7 is a horizontal push rod dilatometer. It transfers the change in length of the sample under investigation via a push rod from the central heating zone of the furnace to the measuring part. The furnace is vacuum-tight, water-cooled and has a graphite tube heating element. Protective tubes may be inserted in the heater tube, thus separating the sample from the furnace chamber. An Al_2O_3 protective tube is used up to 1700°C for measurements under oxidizing atmospheres. The graphite heater provides heating rates up to 50 deg·min⁻¹, and cooling times of 1 h 15 min from 2000° down to 100°C are possible due to the water cooling.

The sample holder tube and the push rod are made of POCO-graphite in order to attain a maximum temperature of 2400°C under protective gas atmospheres (He, Ar).

The measuring cell is held at constant temperature by thermostatic control and contains the inductive displacement transducer providing the measuring signal. Vacuum-tight flanges allow the instrument to be operated under static or dynamic gas atmospheres.

Temperature measurement

W3%Re–W25%Re thermocouples are used up to 2000°C to measure the temperature close to the sample in the sample holder. Since this alloy becomes increasingly brittle when in constant use at temperatures above 2000°C, an infrared optical pyrometer is used above this temperature. The measuring point is the end piece of the sample holder. Since the radiation properties of graphite are very close to those of a black body, temperature measurement is very accurate and is independent of variations in emissivity of different samples. The radiation emitted from the sample holder is controlled by an optical system and fed into a glass fibre optical wave guide [4]. The infrared radiation is transmitted to the Si detector which converts it to an electrical signal which is amplified and adapted for data acquisition as well as temperature control.

The working range of the pyrometer starts at 550°C. From room temperature to 550°C, an additional electronic device incorporating a ramp generator and signal adaptation is adjusted so that the furnace has a heating rate of 50°C. At 550°C, the pyrometer takes over temperature control at the chosen heating rate.

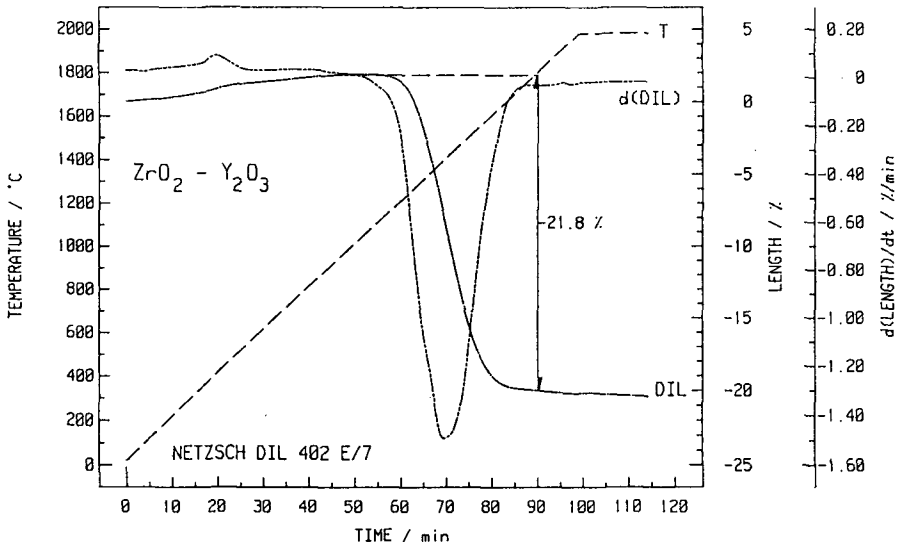

Fig. 2a Sintering of partially stabilized $ZrO_2-Y_2O_3$. Time-scaled with temperature curve (T), change in length (DIL) and its derivative $d(DIL)$

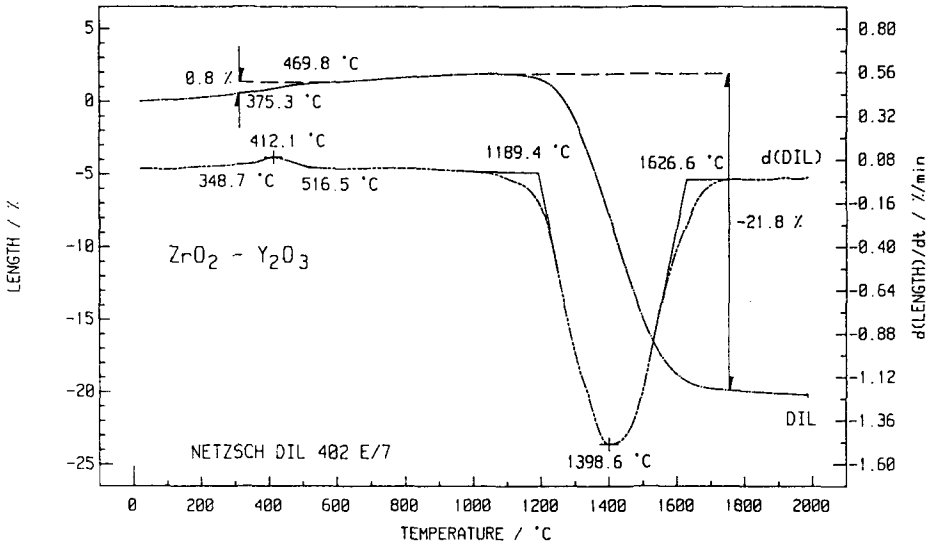

Fig. 2b Temperature-scaled plot of binder burnout and sintering of $ZrO_2-Y_2O_3$, with change in length (DIL) and its derivative $d(DIL)$

Measurements of green ZrO₂ and SSiC containing organic additives

Samples of partially stabilized ZrO₂-Y₂O₃ and SSiC in the green state and containing phenolic resins as binders were investigated. Samples of 10 mm length and 3 mm×3 mm cross-section were cut and polished to obtain parallel faces. Both samples were run under a dynamic Ar atmosphere after evacuating and purging the system twice to prevent oxidation. Measurements on ZrO₂ were carried out up to 2000°C using the WRe thermocouple, whereas SSiC was measured up to 2400°C with the optical pyrometer.

Measurements were made on ZrO₂ with and without rate controlled sintering (RCS) [5]. A threshold value of the rate of change in length was selected and kept constant via software control. As soon as the threshold value was exceeded, the temperature programme was held at the current value. The temperature programme continued with the preset heating rate once the rate of change in length had returned to below this threshold value.

Results

ZrO₂-Y₂O₃

Measurements without RCS are shown in Figs 2a and 2b. Thermal decomposition of the binder starts at 375°C (extrapolated onset temperature from ΔL curve) and finishes at 470°C (extrapolated end temperature from ΔL curve). Following this burnout process there is a change in thermal expansion. This change and the range of the reaction is shown best on the derivative $d(\Delta L) / dt$ curve as a peak signal, for which extrapolated onset, peak and extrapolated end temperatures are shown on Fig. 2b. Densification starts at 1190°C, reaches a maximum value of -1.5%/min at 1400°C, and ends at 1630°C.

Figures 3a and 3b show the results of the same measurement with activated RCS control. A threshold of -0.25%/min was chosen and held constant between 1190° and 1490°C. Adjustment of the heating rate necessary to obtain the constant densification rate leads to the temperature curve shown in Fig. 3a. Instead of the sintering range for the first measurement at constant heating rate, the temperature range of the constant densification rate is determined from this RCS measurement.

Values for total shrinkage are given in time-scaled plots, where the shrinkage in the RCS measurement is determined within the same temperature range. Figure 4 shows the results of both experiments for comparison.

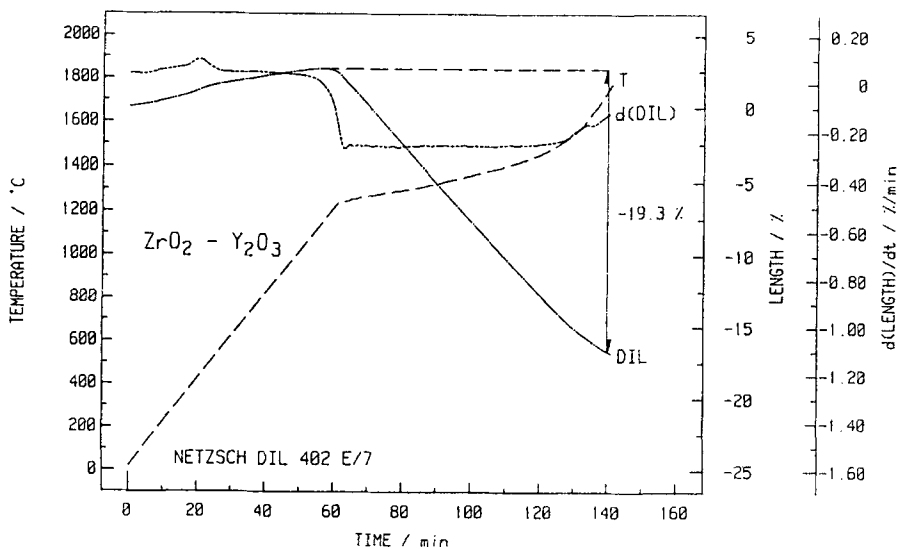

Fig. 3a Rate controlled sintering (RCS) of $ZrO_2 - Y_2O_3$. The temperature curve (T) shows the deviation from the constant heating rate at the start of the RCS control

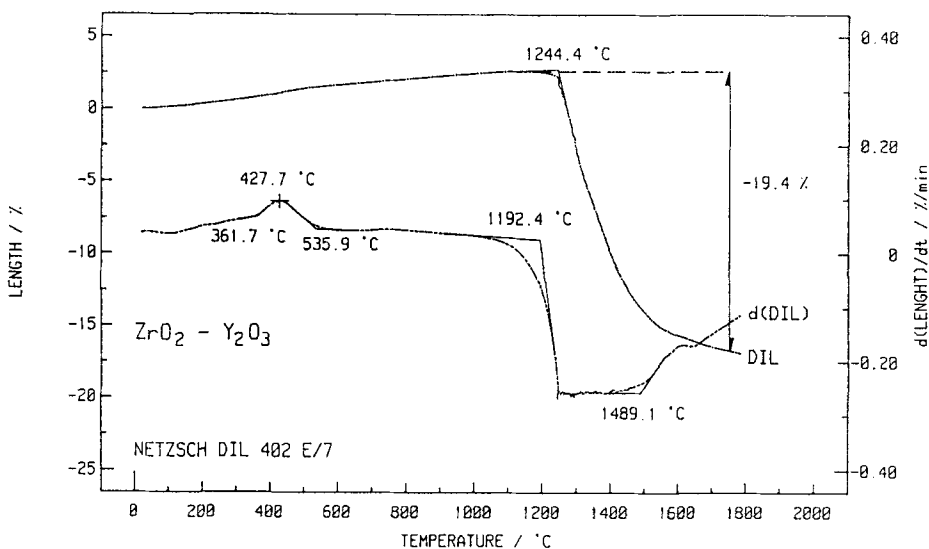

Fig. 3b Temperature-scaled plot of RCS of $ZrO_2 - Y_2O_3$. Start and end of the RCS process are determined from the derivative $d(DIL)$ curve

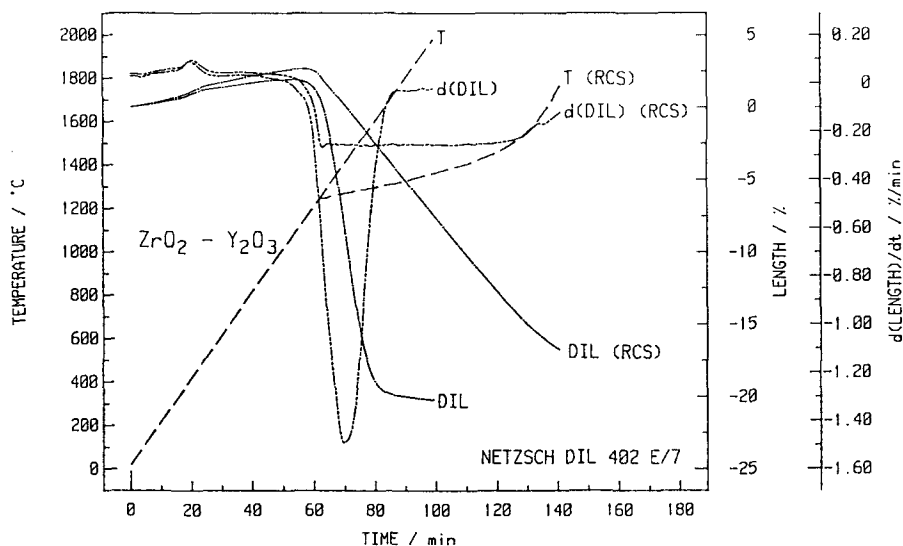

Fig. 4 Time-scaled comparison of the sintering of ZrO_2 - Y_2O_3 , with and without RCS

SSiC

Results of pressureless, dilatometric sintering of SSiC vs. time are shown in Fig. 5a. Since temperature measurement and control were carried out using the optical pyrometer, the temperature curve starts at 550°C. The sample was heated under N_2 to 1000°C. After 10 min at this temperature the gas was changed to Ar. Heating rates were 50 deg·min⁻¹ to 550°C, 10 deg·min⁻¹ to 1000°C and 20 deg·min⁻¹ to the final temperature of 2400°C. Further slight densification occurred on cooling to 1600°C at 20 deg·min⁻¹, as can be seen from the ΔL curve. The total shrinkage was therefore determined at the end of the densification and amounted to 17%.

The heating curve from 1000° to 2400°C is plotted as a function of temperature in Fig. 5b. The derivative $d(\Delta L)/dt$ curve distinctly shows a strongly overlapping three-stage process of densification.

Discussion

ZrO_2

Slight differences in expansion and start of densification between the two samples used are probably due to differences in burnout of the binder. Comparing

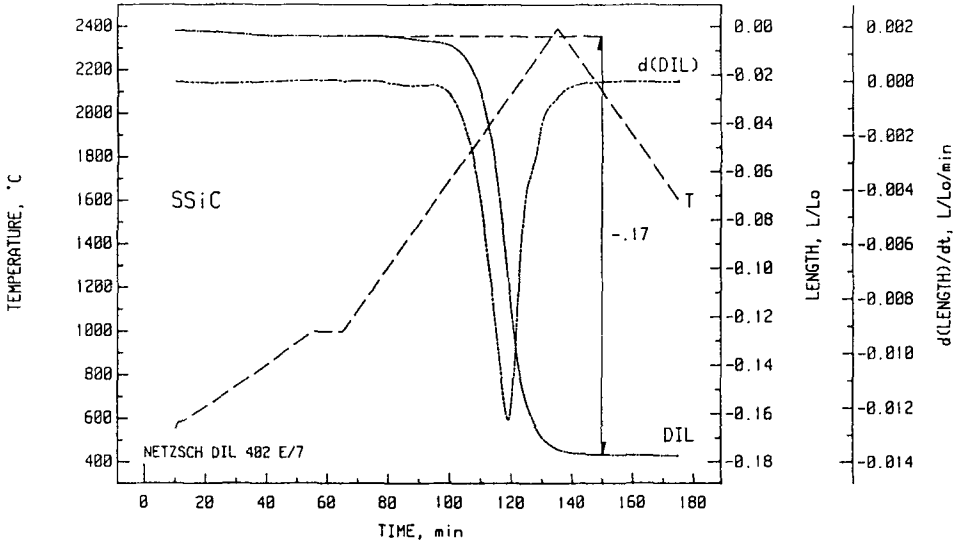

Fig. 5a Sintering of SSiC: time-scaled plot including temperature curve (T), change in length (DIL) and its derivative d(DIL)

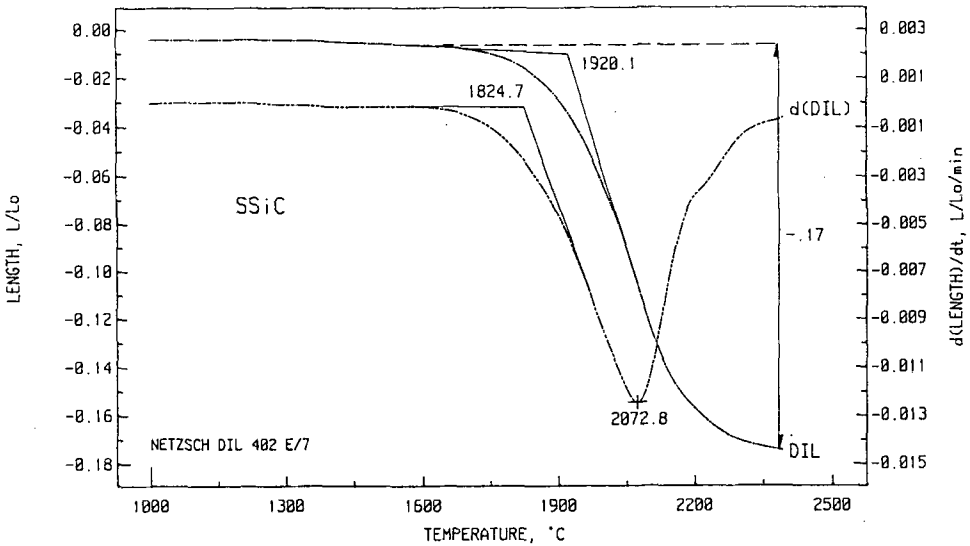

Fig. 5b Sintering of SSiC: temperature-scaled plot of the heating segment between 1000° and 2400°C

the total shrinkage within the same temperature range between measurements with and without RCS, the same densification is obtained, but with RCS the time taken for sintering is lengthened by maintenance of the lower shrinkage rate. On returning to the original heating rate after the period of RCS, the densification rate increases only slowly so that a lower total shrinkage and thus density is obtained with RCS. When comparing this to CTS measurements within the same temperature range, densification is seen not to be complete at 1800°C.

The final density of ZrO₂ without RCS was 93% TD; with RCS it was 79% TD at the end of the heating period [6].

SSiC

Results clearly show that heating SSiC up to only 2400°C allows sintering to be initiated. The derivative curve reveals three strongly overlapping steps during shrinkage of the sample.

Since constant conditions were not maintained after heating to 2400°C, the final density was only 82% TD. The sintering process was therefore incomplete. Resolution and sensitivity of the DIL 402 E/7 are high even between 2000° and 2400°C so that details of the sintering steps are revealed [7, 8].

Conclusions

Sintering experiments performed on partially stabilized ZrO₂-Y₂O₃ and SSiC show that the NETZSCH Dilatometer DIL 407 E/7 is a powerful and versatile thermoanalytical instrument for precise determination of sintering ranges and detailed investigation of the densification process.

The application of rate controlled sintering for the ZrO₂ sample, performed via software control of the temperature programmer, shows that the limiting parameter for densification is temperature rather than densification rate in this case. Thus precise control of the temperature programme is crucial for investigating the sintering process, even at the high temperatures used in these experiments.

References

- 1 U. Dworak, Technische Keramik, Vulkan Verlag, Essen 1988, p. 260.
- 2 E. Kaisersberger and J. Kelly, Int. J. Thermophysics, 10 (1989) 505.
- 3 W.-D. Emmerich, J. Janoschek and E. Kaisersberger, Technische Keramik, Vulkan Verlag, Essen 1988, p. 47.
- 4 C. Gerthsen, H. O. Kneser and H. Vogel, Physik, Springer Verlag, Berlin 1977, p. 421.
- 5 H. E. Exner, Technische Keramik, Vulkan Verlag, Essen 1988, p. 28.
- 6 A. Reckziegel, Technische Keramik, Vulkan Verlag, Essen 1988, p. 254.

- 7 A. Müller-Zell and Ch. Hahn, *Ceramic Materials and Components for Engines*; Proc. of the Second Int. Symposium, Deutsche Keramische Gesellschaft 1986, p. 339.
- 8 T. Mizrah, M. Hoffmann and L. Gauchler, *Ceramic Materials and Components for Engines*; Proc. of the Second Int. Symposium, Deutsche Keramische Gesellschaft 1986, p. 347.

Zusammenfassung — Zur Messung und – in Verbindung mit einer Temperaturprogrammier- und -steuereinheit – zur Steuerung der Temperatur in einem NETZSCH Dilatometer DIL 402 E/7 bis 2400°C wurde ein optisches Pyrometer eingesetzt. Dieses Gerät eignet sich somit zur Untersuchung des Sinterns von technischen Keramikstoffen wie z.B. SiC und ZrO₂. Die Messungen an diesen auch organische Zusätze enthaltenden Materialien zeigen, daß der Sinterbereich im Falle von SiC bei 1800°C beginnt und die endgültige Dichte bei einer Aufheizgeschwindigkeit von 20 deg·min⁻¹ bis 2400°C nicht erreicht wird. Die Verdichtung von ZrO₂ erfolgt zwischen 1000° und 1800°C. Unter Anwendung von geschwindigkeitskontrolliertem Sintern (RCS) kann der Sinterprozeß zwar zeitlich gestreckt werden, man erhält jedoch bei den betreffenden Temperaturen die gleichen Dichten wie ohne RCS.